



# DESIGNLIGHT

SCANDINAVIAN AB

## DOWNLIGHT

E-NR: 74 647 41

ART NR: DB-237MW

EFFEKT POWER	MATERIAL MATERIAL	KELVIN KELVIN	ARMATURFÄRG ARMATURE COLOR	ANSLUTNING CONNECTION	TOTAL LUMEN	USEFUL LUMEN
3,5W	ALUMINIUM	3000K	MATT WHITE	350MA	400LM	301LM

CE, RoHS

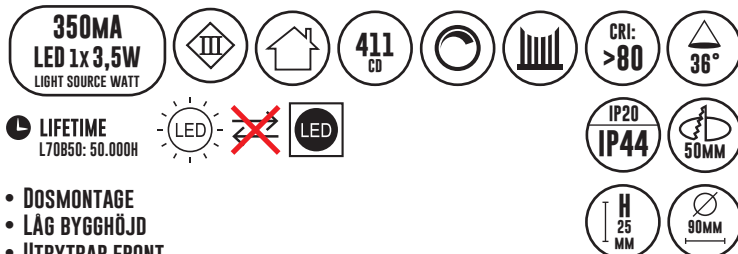

- DOSMONTAGE
- LÅG BYGGHÖJD
- UTBYTBAR FRONT

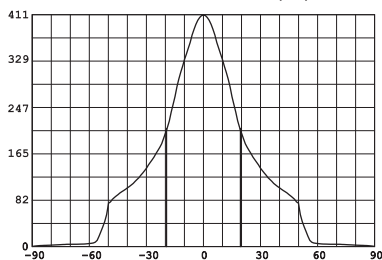
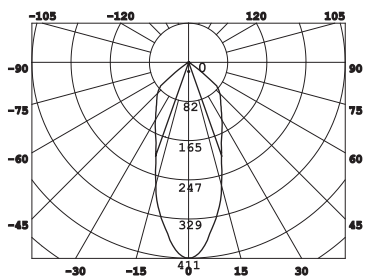

Avstånd	Belysningsstyrka	Spridnings vinkel 36°	Diam.
0.50m	354.74lx 1437.93lx		35.83cm
1.00m	261.19lx 409.48lx		71.66cm
1.50m	116.08lx 181.99lx		107.49cm
2.00m	65.39lx 102.37lx		143.33cm
3.00m	29.02lx 45.00lx		214.99cm

### 1. Stäng av strömmen/Turn off the power

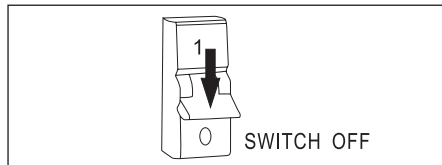

### 2. Borra hål i taket/Drill hole in ceiling

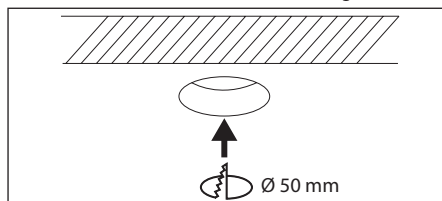

### 3. Anslut till LED-drivern/Connect to LED driver

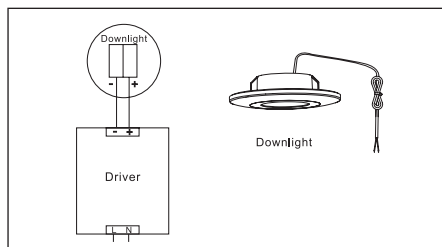

### Mått/Dimension

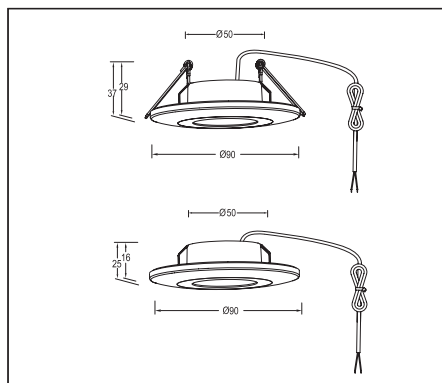

Designlight Scandinavian AB  
DB-237MW

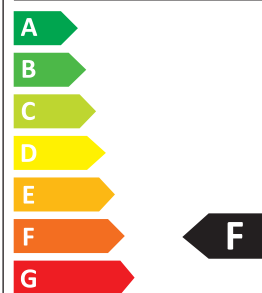

4 kWh/1000h



2019/2015

### SAKERHET:

- 1 Läs igenom hela manualen noggrant före installation.
- 2 Kontrollmät ALLTID diametern före håltagning i tak.
- 3 Fästskruarna är ej utbytbara. Hela armaturen måste bytas när ljuskällan är förbrukad.
- 4 Installation ska utföras av behörig elektriker.
- 5 Ljuskällan är ej utbytbar. Hela armaturen måste bytas när ljuskällan är förbrukad.

### SAFETY:

- 1 Read the entire manual carefully before installation.
- 2 ALWAYS check the diameter before drilling holes in the ceiling.
- 3 Make sure that the power is switched off before installation or maintenance.
- 4 Installation must be performed by a qualified electrician.
- 5 The light source of this luminaire is not replaceable; when the light source reaches its end of life the whole luminaire shall be replaced.

1.900K	2.700-3.000K	4.000-4.500K	4.800K	5.000-5.000K	7.000-7.500K	10.000K
STEARINLJUS CANDLE	VARMVIT WARM WHITE	NATURLIG VIT NATURAL WHITE	SOLLJUS DIRECT SUN	VITT DAGSLJUS DAY WHITE	KALLVIT COOL WHITE	BLÅ HIMMEL BLUE SKY

DESIGNLIGHT  
SCANDINAVIAN AB

DESIGNLIGHT SCANDINAVIAN AB · TOFFELVÄGEN 1 · 342 60 MOHEDA  
KUNDCENTER: TELEFON 0472-716 10 · FAX 0472-716 09 · INFO@DESIGNLIGHT.NU · WWW.DESIGNLIGHT.NU